



MU Series Mini Free Mount Cylinder

Compendium of MU Series

Seven bore size are available

Bore size: 4, 6, 8, 10, 12, 16, 20

Magnetic switch slots around the cylinder body

There are magnetic switch slots around the cylinder body convenient to install inducting switch.

Two kinds of rod type

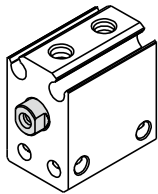

Female thread

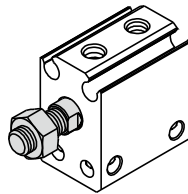

Male thread

Mounted from 4 directions

Cylinder can be mounted from 4 directions, and convenient to install and use.

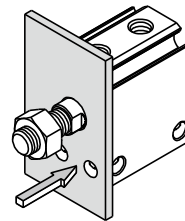

Front mounting

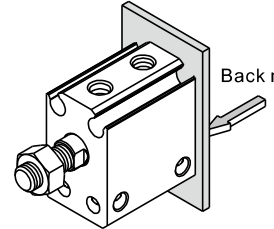

Back mounting

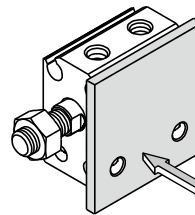

Right mounting

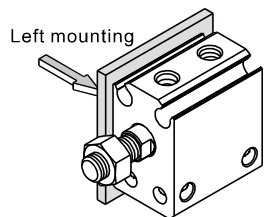

Left mounting

Mounted side by side

Multitudinous cylinder can be mounted side by side to save space.

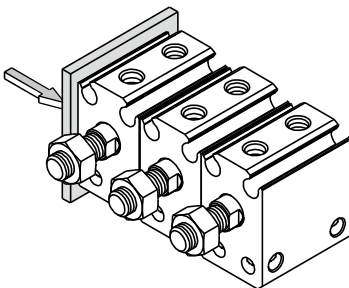

Mounted side by side from left

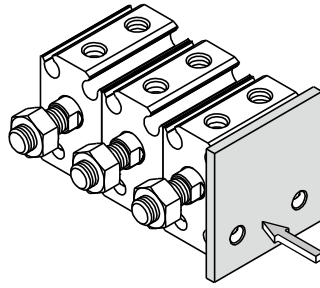

Mounted side by side from right

Criteria for selection: Cylinder thrust

Unit : Newton(N)

Bore size	Rod size	Acting type	Pressure area(mm ²)	Operating pressure(MPa)							
				0.1	0.2	0.3	0.4	0.5	0.6	0.7	
4	2	Single acting_push	12.6	-	0.3	1.6	2.8	4.1	5.3	6.6	
		Double acting	Push side	12.6	1.3	2.5	3.8	5.0	6.3	7.6	8.8
			Pull side	9.4	0.9	1.9	2.8	3.8	4.7	5.6	6.6
6	4	Single acting_push	28.3	-	-	5.1	7.9	10.7	13.5	16.4	
		Double acting	Push side	28.3	-	5.7	8.5	11.3	14.2	17.0	19.8
			Pull side	15.7	-	3.1	4.7	6.3	7.9	9.4	11.0
8	5	Single acting_push	50.3	-	-	8.3	13.4	18.4	23.4	28.5	
		Double acting	Push side	50.3	-	10.1	15.1	20.1	25.2	30.2	35.2
			Pull side	30.6	-	6.1	9.2	12.2	15.3	18.4	21.4
10	6	Single acting_push	78.5	-	8.7	16.5	24.4	32.2	40.1	47.9	
		Double acting	Push side	78.5	1.3	15.7	23.6	31.4	39.3	47.1	55.0
			Pull side	50.3	0.9	10.1	15.1	20.1	25.2	30.2	35.2
12	6	Single acting_push	113.1	-	13.6	24.9	36.2	47.5	58.9	70.2	
		Double acting	Push side	113.1	11.3	22.6	33.9	45.2	56.5	67.9	79.2
			Pull side	84.8	8.5	17.0	25.4	33.9	42.4	50.9	59.4
16	8	Single acting_push	201.1	-	27.0	47.1	67.2	87.3	107.4	127.5	
		Double acting	Push side	201.1	20.1	40.2	60.3	80.4	100.5	120.6	140.7
			Pull side	150.8	15.1	30.2	45.2	60.3	75.4	90.5	105.6
20	10	Single acting_push	314.2	-	36.8	68.2	99.7	131.1	162.5	193.9	
		Double acting	Push side	314.2	31.4	62.8	94.2	125.7	157.1	188.5	219.9
			Pull side	236.5	23.7	47.1	70.7	94.2	117.8	141.4	164.9

Installation and application



- When load changes in the work, the cylinder with abundant output capacity shall be selected.
- Relative cylinder with high temperature resistance or corrosion resistance shall be chosen under the condition of high temperature or corrosion.
- Necessary protection measure shall be taken in the environment with higher humidity, much dust or water drops, oil dust and welding dregs.
- Dirty substances in the pipe must be eliminated before cylinder is connected with pipeline to prevent the entrance of particles into the cylinder.
- The medium used by cylinder shall be filtered to 40μm or below.
- As both of the front cover and piston of the cylinder are short, typically too large stroke can not be selected.
- Anti-freezing measure shall be adopted under low temperature environment to prevent moisture freezing.
- The cylinder shall avoid the influence of side load in operation to maintain the normal work of cylinder and extend the service life.
- If the cylinder is dismantled and stored for a long time, please conduct anti-rust treatment to the surface. Anti-dust caps shall be added in air inlet and outlet ports. The front and back cover can not be dismantled, which shall be especially noticed.



Mini free mount cylinder

MU Series



Specification

Bore size(mm)	4	6	8	10	12	16	20
Acting type	MU : Double acting		MSU : Single acting_Pull type				
Fluid	Air(to be filtered by 40µm filter element)						
Operating pressure	Double acting	0.2~0.7MPa(29~100psi)		0.15~0.7MPa(22~100psi)			
	Single acting	0.3~0.7MPa(44~100psi)		0.2~0.7MPa(29~100psi)			
Proof pressure	1,2MPa(175psi)						
Temperature °C	-20~70						
Speed range mm/s	Double acting : 30~500		Single acting : 50~500				
Stroke tolerance	+1.0 0						
Cushion type	No					Bumper	
Port size	M3×0,5					M5×0,8	

Add) Refer to P362 for detail of sensor switch.

Symbol

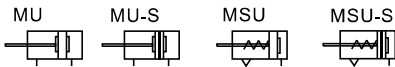

Product feature

1. JIS standard is implemented.
2. Cylinder can be mounted from 4 directions, and convenient to install and use.
3. Multitudinous cylinder can be mounted side by side to save space.
4. The front end of the cylinder is designed with boss. Centering can be done easily.
5. The internal diameter of the body is treated with rolling followed by the treatment of hard anodizing, forming an excellent abrasion resistance and durability.
6. With magnet type is of the feature of position sensing.
7. There are magnetic switch slots around the cylinder body, which is convenient to install inducting switch.
8. The seal of piston adopts heterogeneous two-way seal structure. It has compact dimension and the function of grease reservation.

Stroke

Bore size (mm)	Standard stroke (mm)		Max.std stroke
4	Double acting	4 6 8 10 15 20	20
	Single acting	4 6	6
6	Double acting	4 6 8 10 15 20 25 30	30
	Single acting	4 6 8	8
8	Double acting	4 6 8 10 15 20 25 30	30
	Single acting	4 6 8 10	10
10	Double acting	4 6 8 10 15 20 25 30	30
	Single acting	4 6 8 10	10
12	Double acting	5 10 15 20 25 30 35 40 45 50	50
	Single acting	5 10	10
16	Double acting	5 10 15 20 25 30 35 40 45 50	50
	Single acting	5 10	10
20	Double acting	5 10 15 20 25 30 35 40 45 50	50
	Single acting	5 10	10

- Note) 1. Please contact the company for other special strokes.
 2. The dimensions of non-std stroke cylinder has the same dimensions as the next longer stroke std. stroke cylinder. e.g. 23mm stroke cylinder has the same dimensions of 25 std. stroke cylinder.

Ordering code

MU □ 12 × 10 S □
 MSU □ 12 × 10 S □

① ② ③ ④ ⑤ ⑥

① Model	② Body mounted type	③ Bore size	④ Stroke	⑤ Magnet	⑥ Rod type
MU: Mini free mount cylinder (double acting)	No this code	4	Refer to stroke table for details	Blank: Without magnet S: With magnet	Blank: No thread; B: Male thread
		6			
		8			
		10			
		12			
MSU: Mini free mount cylinder (single acting-push)	Blank: Transverse mounting R: Axial mounting	12	Refer to stroke table for details	Blank: Without magnet S: With magnet	Blank: Female thread B: Male thread
		16			
		20			

Mini free mount cylinder

MU Series

Inner structure and material of major parts

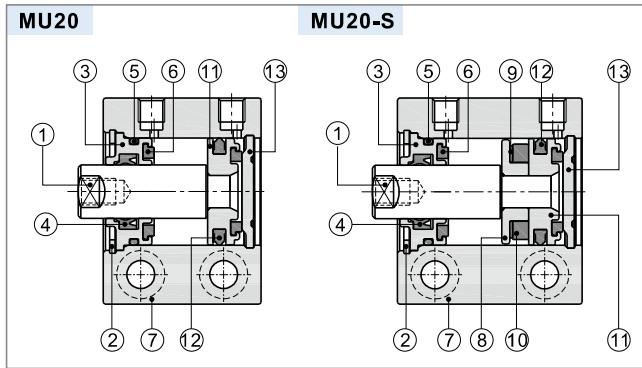

NO.	Item	Material
1	Piston rod	Stainless steel or Carbon steel with 20μm chrome plated
2	C clip	Spring steel
3	Front cover	Aluminum alloy
4	Front cover packing	NBR
5	O-ring	NBR
6	Bumper	TPU
7	Body	Aluminum alloy
8	Magnet holder	Brass(Φ12)/Aluminum alloy(Others)
9	Magnet washer	NBR
10	Magnet	Sintered metal (Neodymium-iron-boron)
11	Piston	Brass(Φ12,16)/Aluminum alloy(Others)
12	Piston seal	NBR
13	Back cover	No(Φ12,16)/Aluminum alloy(Others)

Dimensions

Φ4

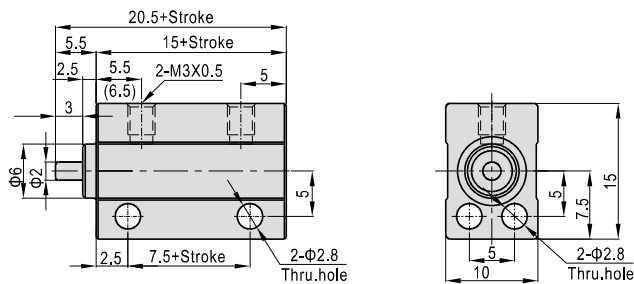

Φ4 (Male thread)

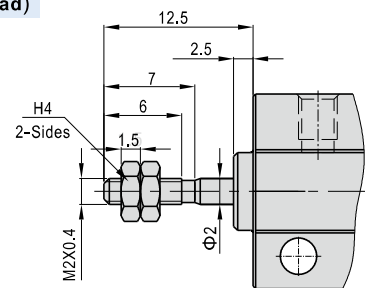

[Note] The value in the "()" is single-acting type's value.

Φ6~Φ10

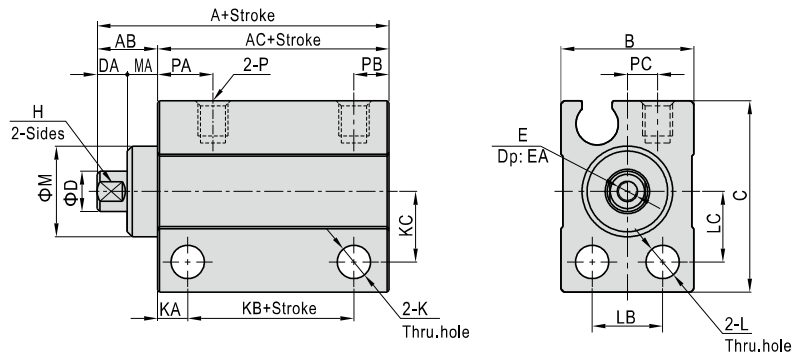

Bore size\Item	A			AC			KB			AB	B	C	D		DA	E	EA	H		K	KA	KC	L	LB	LC	M	MA	P		
	With magnet	Without magnet		With magnet	Without magnet		MU	MSU	MU				MSU	PA				PB	PC											
6	24	18	11.5	19	13	6.5	6	13	19	4	3.5	3	M2.5×0.45	5	3.5	3	3.3	3	7	3.3	7	7	9	3	M3×0.5	5.5	3.5	3		
8	24	18	11.5	19	13	6.5	6	13	21	5	5	3	M3×0.5	6	4.5	3.3	3	8	3.3	7	8	11	3	M3×0.5	5.5	3.5	3			
10	24	18	11.5	19	13	6.5	6	13.5	22	6	6	3	M3×0.5	6	5	3.3	3	8.5	3.3	7	8.5	12	3	M3×0.5	5.5	3.5	3.5			

Φ6~Φ10 (Male thread)

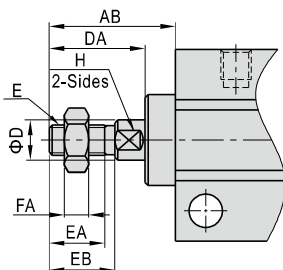

Bore size\Item	AB	D(MU)	D(MSU)	DA	E	EA	EB	FA	H
6	12.5	4	3.5	9.5	M3×0.5	5.5	6.5	2.4	3.5
8	14.5	5	5	11.5	M4×0.7	7	8.5	3	4
10	16.5	6	6	13.5	M5×0.8	9	10.5	4	5

[Note] The unmarked dimensions are the same as Female type.

Mini free mount cylinder

MU Series

Φ12~Φ20(Transverse mounted)

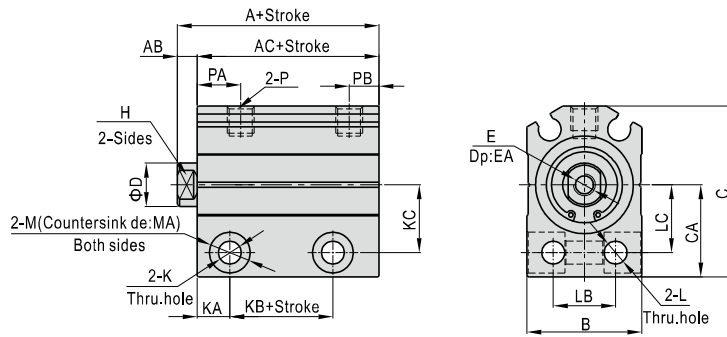

Bore size\Item	A	AC	KB	A	AC	KB	AB	B	C	CA	D	E	EA	H	K	KA	KC	L	LB	LC	M	MA	P	PA	PB
	With magnet			Without magnet																					
12	25,5(30,5)	22(27)	8,5(13,5)	20,5(25,5)	17(22)	3,5(8,5)	3,5	17	28,5	15,5	6	M3×0,5	6	5	4,3	6	11	4,3	8	11	7,5	7	M5×0,8	7,5	5
16	27(32)	23,5(28,5)	9(14)	22(27)	18,5(23,5)	4(9)	3,5	21	31,5	17	8	M4×0,7	8	6	4,3	6	12,5	4,3	11,5	12,5	7,5	7	M5×0,8	8	5,5
20	29(34)	24,5(29,5)	10,5(15,5)	24(29)	19,5(24,5)	5,5(10,5)	4,5	25	38,5	21	10	M5×0,8	7	8	5,5	7	15,5	5,5	13,5	15,5	9	9	M5×0,8	9	5,5

[Note] The value in the "()" are single-acting type's value.

Φ12~Φ20(Axial mounted)

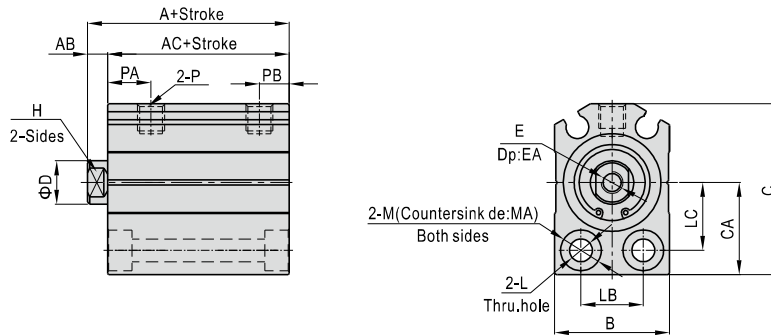

Bore size\Item	A	AC	A	AC	AB	B	C	D	CA	E	EA	H	L	LB	LC	M	MA	P	PA	PB
	With magnet		Without magnet																	
12	25,5(30,5)	22(27)	20,5(25,5)	17(22)	3,5	17	28,5	6	15,5	M3×0,5	6	5	4,3	8	11	7,5	4,5	M5×0,8	7,5	5
16	27(32)	23,5(28,5)	22(27)	18,5(23,5)	3,5	21	31,5	8	17	M4×0,7	8	6	4,3	11,5	12,5	7,5	4,5	M5×0,8	8	5,5
20	29(34)	24,5(29,5)	24(29)	19,5(24,5)	4,5	25	38,5	10	21	M5×0,8	7	8	5,5	13,5	15,5	9	5,5	M5×0,8	9	5,5

[Note] The value in the "()" are single-acting type's value.

Φ12~Φ20(Male thread)

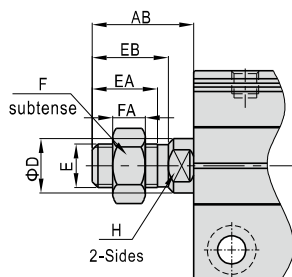

Bore size\Item	AB	D	E	EA	EB	F	FA	H
12	14	6	M5×0,8	9	10,5	8	4	5
16	15,5	8	M6×1,0	10	12	10	5	6
20	18,5	10	M8×1,25	12	14	12	6	8

[Note] The unmarked dimensions are the same as Female type.