

# Compact cylinder—ACQ Series

## Compendium of ACQ Series

**In accordance with JIS standard**

**Magnetic switch slots around the cylinder body**  
There are magnetic switch slots around the cylinder body convenient to install inducting switch.

**Two kinds of rod type**

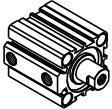

Female thread

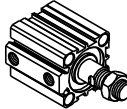

Male thread

**Multi-mounting accessories**

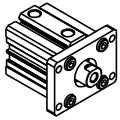

FA Type

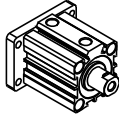

FB Type

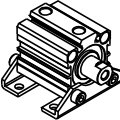



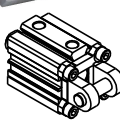



LB Type



CB Type

**Thirteen bore size are available**  
Bore size: 12, 16, 20, 25, 32, 40, 50, 63, 80, 100, 125, 140, 160

**Multi-type cylinder**

ACQ: Compact cylinder (Double acting)	
ASQ: Compact cylinder (Single acting-push)	
ATQ: Compact cylinder (Single acting-pull)	
ACQD: Compact cylinder (Double rod)	
ACQJ: Compact cylinder (Adjustable stroke)	
TACQ: Compact cylinder (Double acting with guider)	

**Compact structure**  
C clip is adopted to connect the cylinder body and back cover or front cover, and riveted structure is adopted to connect piston and piston rod to make it compact and reliable.

### Criteria for selection: Cylinder thrust

Unit : Newton(N)

Bore size	Rod size	Acting type	Pressure area(mm <sup>2</sup> )	Operating pressure(MPa)							
				0.1	0.2	0.3	0.4	0.5	0.6	0.7	
12	6	Single acting	Push side	113.1	-	13.6	24.9	36.2	47.5	58.9	70.2
			Pull side	84.8	-	8.0	16.4	24.9	33.4	41.9	50.4
		Double acting	Push side	113.1	11.3	22.6	33.9	45.2	56.5	67.9	79.2
			Pull side	84.8	8.5	17.0	25.4	33.9	42.4	50.9	59.4
16	8	Single acting	Push side	201.1	-	27.0	47.1	67.2	87.3	107.4	127.5
			Pull side	150.8	-	17.0	32.0	47.1	62.2	77.3	92.4
		Double acting	Push side	201.1	20.1	40.2	60.3	80.4	100.5	120.6	140.7
			Pull side	150.8	15.1	30.2	45.2	60.3	75.4	90.5	105.6
20	10	Single acting	Push side	314.2	-	36.8	68.2	99.7	131.1	162.5	193.9
			Pull side	235.6	-	21.1	44.7	68.2	91.8	115.4	138.9
		Double acting	Push side	314.2	31.4	62.8	94.2	125.7	157.1	188.5	219.9
			Pull side	235.6	23.6	47.1	70.7	94.2	117.8	141.4	164.9
25	12	Single acting	Push side	490.9	18.1	67.2	116.3	165.3	214.4	263.5	312.6
			Pull side	377.8	6.8	44.6	82.3	120.1	157.9	195.7	233.4
		Double acting	Push side	490.9	49.1	98.2	147.3	196.3	245.4	294.5	343.6
			Pull side	377.8	37.8	75.6	113.3	151.1	188.9	226.7	264.4
32	16	Single acting	Push side	804.2	27.4	107.8	188.3	268.7	349.1	429.5	510.0
			Pull side	603.2	7.3	67.6	128.0	188.3	248.6	308.9	369.2
		Double acting	Push side	804.2	80.4	160.8	241.3	321.7	402.1	482.5	563.0
			Pull side	603.2	60.3	120.6	181.0	241.3	301.6	361.9	422.2
40	16	Single acting	Push side	1256.6	44.7	170.3	296.0	421.7	547.3	673.0	798.6
			Pull side	1055.6	24.6	130.1	235.7	341.2	446.8	552.3	657.9
		Double acting	Push side	1256.6	125.7	251.3	377.0	502.7	628.3	754.0	879.6
			Pull side	1055.6	105.6	211.1	316.7	422.2	527.8	633.3	738.9
50	20	Single acting	Push side	1963.5	96.3	292.7	489.0	685.4	881.7	1078.1	1274.4
			Pull side	1649.3	64.9	229.9	394.8	559.7	724.7	889.6	1054.5
		Double acting	Push side	1963.5	196.3	392.7	589.0	785.4	981.7	1178.1	1374.4
			Pull side	1649.3	164.9	329.9	494.8	659.7	824.7	989.6	1154.5
63	20	Single acting	Push side	3117.2	141.7	453.4	765.2	1076.9	1388.6	1700.3	2012.1
			Pull side	2803.1	110.3	390.6	670.9	951.2	1231.5	1511.9	1792.2
		Double acting	Push side	3117.2	311.7	623.4	935.2	1246.9	1558.6	1870.3	2182.1
			Pull side	2803.1	280.3	560.6	840.9	1121.2	1401.5	1681.9	1962.2
80	25	Double acting	Push side	5026.5	502.7	1005.3	1508.0	2010.6	2513.3	3015.9	3518.6
			Pull side	4535.7	453.6	907.1	1360.7	1814.3	2267.8	2721.4	3175.0
		Double acting	Push side	7854.0	785.4	1570.8	2356.2	3141.6	3927.0	4712.4	5497.8
			Pull side	7049.7	705.0	1409.9	2114.9	2819.9	3524.9	4229.8	4934.8
100	32	Double acting	Push side	12271.8	1227.2	2454.4	3681.5	4908.7	6135.9	7363.1	8590.2
			Pull side	11467.6	1146.8	2293.5	3440.3	4587.0	5733.8	6880.6	8027.3
		Double acting	Push side	15393.8	1539.4	3078.8	4618.1	6157.5	7696.9	9236.3	10775.7
			Pull side	14589.6	1459.0	2917.9	4376.9	5835.8	7294.8	8753.8	10212.7
160	40	Double acting	Push side	20106.2	2010.6	4021.2	6031.9	8042.5	10053.1	12063.7	14074.3
			Pull side	18849.6	1885.0	3769.9	5654.9	7539.8	9424.8	11309.8	13194.7

### Installation and application



1. When load changes in the work, the cylinder with abundant output capacity shall be selected.
2. Relative cylinder with high temperature resistance or corrosion resistance shall be chosen under the condition of high temperature or corrosion.
3. Necessary protection measure shall be taken in the environment with higher humidity, much dust or water drops, oil dust and welding dregs.
4. Dirty substances in the pipe must be eliminated before cylinder is connected with pipeline to prevent the entrance of particles into the cylinder.
5. The medium used by cylinder shall be filtered to 40µm or below.
6. As both of the front cover and piston of the cylinder are short, typically too large stroke can not be selected.
7. Anti-freezing measure shall be adopted under low temperature environment to prevent moisture freezing.
8. The cylinder shall avoid the influence of side load in operation to maintain the normal work of cylinder and extend the service life.
9. If the cylinder is dismantled and stored for a long time, please conduct anti-rust treatment to the surface. Anti-dust caps shall be added in air inlet and outlet ports. The front and back cover can not be dismantled, which shall be especially noticed.
10. C clip Installation:
  - 10.1. Removal & Installation of C clip must be done with proper tool & care.
  - 10.2. Ensure C clip is securely fitted into the proper slot to prevent leakage.

# Compact cylinder

## ACQ Series



### Specification

Bore size(mm)		12	16	20	25	32	40	50	63	80	100
Acting type		Double acting									
		Single acting_Push type、Single acting_Pull type									
Fluid		Air(to be filtered by 40μm filter element)									
Operating pressure	Double acting	0.15~1.0MPa(22~145psi)									
	Single acting	0.2~1.0MPa(28~145psi)									
Proof pressure		1.5MPa(215psi)									
Temperature °C		-20~70									
Speed range mm/s		Double acting : 30~500 Single acting : 50~500									
Stroke tolerance		Stroke≤100 <sup>+1.0</sup> <sub>0</sub>					Stroke>100 <sup>+1.5</sup> <sub>0</sub>				
Cushion type		Bumper									
Port size [Note1]		M5×0.8			1/8"			1/4"		3/8"	

[Note1] PT thread, G thread thread and NPT thread are available.  
Add) Refer to P362 for detail of sensor switch.

### Symbol

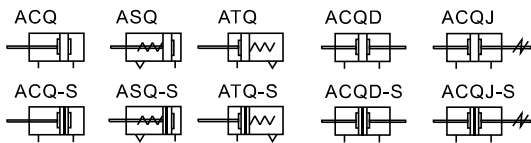

### Stroke

Bore size (mm)		Standard stroke (mm)										Max.std stroke				
		5	10	15	20	25	30	35	40	45	50					
12	Double acting	5	10	15	20	25	30	35	40	45	50	50				
	Single acting	5	10	15	20							20				
16	Double acting	5	10	15	20	25	30	35	40	45	50	55	60			
	Single acting	5	10	15	20								20			
20	Double acting	5	10	15	20	25	30	35	40	45	50	60	70	80	90	100
	Single acting	5	10	15	20	25	30									30
25	Double acting	5	10	15	20	25	30	35	40	45	50	60	70	80	90	100
	Single acting	5	10	15	20	25	30									
32	Double acting	5	10	15	20	25	30	35	40	45	50	60	70	80	90	100
	Single acting	5	10	15	20	25	30									
40	Double acting	5	10	15	20	25	30	35	40	45	50	60	70	80	90	100
	Single acting	5	10	15	20	25	30									
50	Double acting	5	10	15	20	25	30	35	40	45	50	60	70	80	90	100
	Single acting	5	10	15	20	25	30									
63	Double acting	5	10	15	20	25	30	35	40	45	50	60	70	80	90	100
	Single acting	5	10	15	20	25	30									
80	Double acting	5	10	15	20	25	30	35	40	45	50	60	70	80	90	100
	Single acting	5	10	15	20	25	30									
100	Double acting	5	10	15	20	25	30	35	40	45	50	60	70	80	90	100
	Single acting	5	10	15	20	25	30									

Note) 1. Please contact the company for other special strokes.  
2. The dimensions of non-std stroke cylinder has the same dimensions as the next longer stroke std. stroke cylinder, e.g. 23mm stroke cylinder has the same dimensions of 25 std. stroke cylinder.

### Product feature

- JIS standard is implemented.
- C clip is adopted to connect the cylinder body and back cover or front cover, and riveted structure is adopted to connect piston and piston rod to make it compact and reliable.
- The internal diameter of the body is treated with rolling followed by the treatment of hard anodizing, forming an excellent abrasion resistance and durability.
- The seal of piston adopts heterogeneous two-way seal structure. It has compact dimension and the function of grease reservation.
- Compact structure can effectively save installation space.
- There are magnetic switch slots around the cylinder body, which is convenient to install inducting switch.
- Installing accessories with various specifications are optional.

### Ordering code

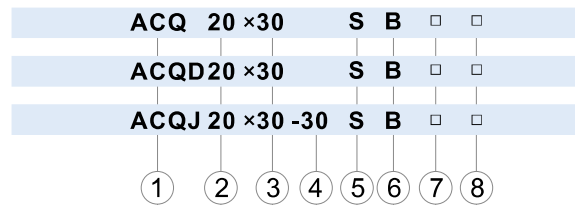

① Model	② Bore size	③ Stroke	④ Adjustable Stroke	⑤ Magnet	⑥ Rod type	⑦ Mounting type [Note1]	⑧ Thread type [Note2]
ACQ: Compact cylinder (Double acting)	12 16 20 25 32 40 50 63 80 100	Refer to stroke table for details	No this code	Blank: Without magnet S: With magnet	Blank: Female thread B: Male thread	Blank: No accessories FA: FA type FB: FB type CB: CB type LB: LB type	Blank: PT G: G T: NPT
ASQ: Compact cylinder (Single acting-push)	12 16 20 25 32 40 50 63						
ATQ: Compact cylinder (Single acting-pull)	12 16 20 25 32 40 50 63						
ACQD: Compact cylinder (Double rod)	12 16 20 25 32 40 50 63						
ACQJ: Compact cylinder (Adjustable stroke)	80 100						
			10 20 30 40 50 75 100			Blank: No accessories FA: FA type FB: FB type LB: LB type	

[Note1] Please refer to page 120~121 for accessory parts.  
[Note2] Standard thread is blank here.

# Compact cylinder

## ACQ Series

### Inner structure and material of major parts

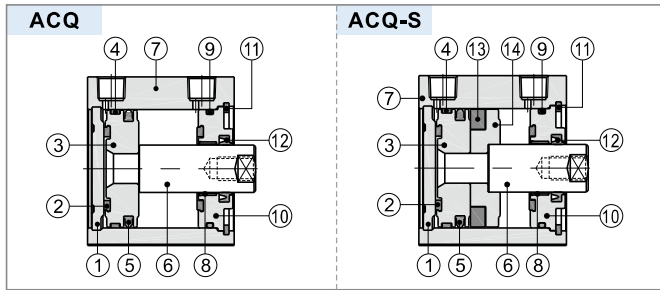

NO.	Item	Material
1	Back cover	No(Φ12, 16)\Aluminum alloy(Others)
2	Bumper	TPU(Φ12~25)\NBR(Others)
3	Piston	Brass(Φ12, 16)\Aluminum alloy(Others)
4	Wear ring	No(Φ12~32)\Wear resistant material(Others)
5	Piston seal	NBR
6	Piston rod	Carbon steel with 20μm chrome plated
7	Body	Aluminum alloy
8	Bushing	No(Φ12~32)\Wear resistant material(Others)
9	O-ring	NBR
10	Front cover	Aluminum alloy
11	C clip	Spring steel
12	Front cover packing	NBR
13	Magnet	Sintered metal(Neodymium-iron-boron)(Φ12~25)\Plastic(Others)
14	Magnet holder	Brass(Φ12, 16)\Aluminum alloy(Others)

### Dimensions

#### ACQ

Φ12, Φ16

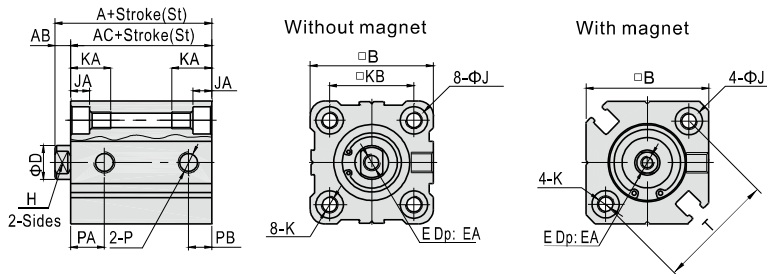

Φ20, Φ25

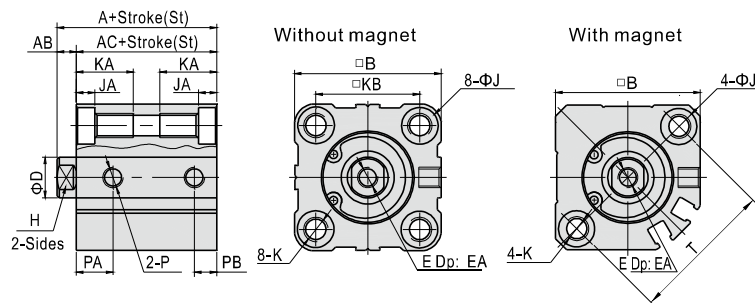

Type	Without magnet						With magnet						Without magnet				With magnet								
	A			AC			A	AC	AB	B	D	E	EA	H	J	JA	K	KA	KB	P	PA	PB	PA	PB	T
Stroke	St≤50	St=55	St≥60	St≤50	St=55	St≥60	A	AC	AB	B	D	E	EA	H	J	JA	K	KA	KB	P	PA	PB	PA	PB	T
12	20.5	-	-	17	-	-	31.5	28	3.5	25	6	M3×0.5	6	5	6	3.5	M4×0.7 Thru.hole:Φ3.4	11	15.5	M5×0.8	7.5	5	9	7	22
16	22	22	22	18.5	18.5	18.5	34	30.5	3.5	29	8	M4×0.7	8	6	6	3.5	M4×0.7 Thru.hole:Φ3.4	11	20	M5×0.8	8	5.5	9.5	5.5	28
20	24	-	34	19.5	-	29.5	36	31.5	4.5	36	10	M5×0.8	7	8	9	5.5	M6×1.0 Thru.hole:Φ5.2	17	25.5	M5×0.8	9	5.5	9.5	5.5	36
25	27.5	-	37.5	22.5	-	32.5	37.5	32.5	5	40	12	M6×1.0	12	10	9	5.5	M6×1.0 Thru.hole:Φ5.2	17	28	M5×0.8	11	5.5	11	5.5	40

Φ32-Φ100 (Strokes≤100)

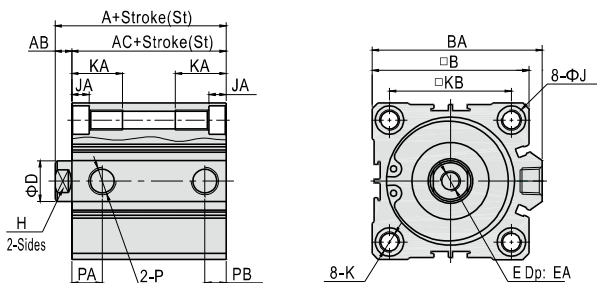

Item	A(Without magnet)		A (With magnet)	AB	AC(Without magnet)		AC (With magnet)	B	BA	D	E
	St≤50	St≥60			St≤50	St≥60					
Bore size	St≤50	St≥60	(With magnet)	AB	St≤50	St≥60	(With magnet)	B	BA	D	E
32	30	40	40	7	23	33	33	45	49.5	16	M8×1.25
40	36.5	46.5	46.5	7	29.5	39.5	39.5	53	57	16	M8×1.25
50	38.5	48.5	48.5	8	30.5	40.5	40.5	64	71	20	M10×1.5
63	44	54	54	8	36	46	46	77	84	20	M10×1.5
80	53.5	63.5	63.5	10	43.5	53.5	53.5	98	104	25	M16×2.0
100	65	75	75	12	53	63	63	117	123.5	32	M20×2.5

Item	Bore size	EA	H	J	JA	K	K Note	KB	P	Without magnet		With magnet	
										PA	PB	PA	PB
32	St=5	13	14	9	5.5	M6×1.0 Thru.hole:Φ5.2	17	34	1/8"	7.5	6.5	10.5	7.5
	St>5									10.5	7.5		
40	St=5	13	14	9	5.5	M6×1.0 Thru.hole:Φ5.2	17	40	1/8"	11	8	11	8
	St>5									9	9		
50	St=5	15	17	10.5	6.5	M8×1.25 Thru.hole:Φ6.8	22	50	1/4"	10.5	10.5	10.5	10.5
	St≥25						28.5			10.5	10.5		
63	St=20	15	17	14	9	M10×1.5 Thru.hole:Φ8.5	27	60	1/4"	14	9.5	15	10.5
	St≤15						thread			(15)	(10.5)		
80	St=20	20	22	17	11	M12×1.75 Thru.hole:Φ10.3	35.5	77	3/8"	16	14	16	14
	St≤15						thread						
100	St=20	26	27	17	11	M12×1.75 Thru.hole:Φ10.3	35.5	94	3/8"	20	17.5	20	17.5
	St≤15						thread						

Note: PA/PB in "( )" is the value when stroke > 5.

Note) The dimensions of non-std stroke cylinder has the same dimensions as the next longer stroke std. stroke cylinder. e.g. 55mm stroke cylinder has the same dimensions of 60 std. stroke cylinder.

# Compact cylinder

## ACQ Series

### ASQ

Φ12, Φ16

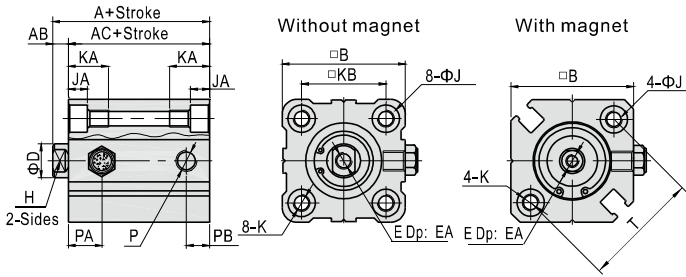

### ATQ

Φ12, Φ16

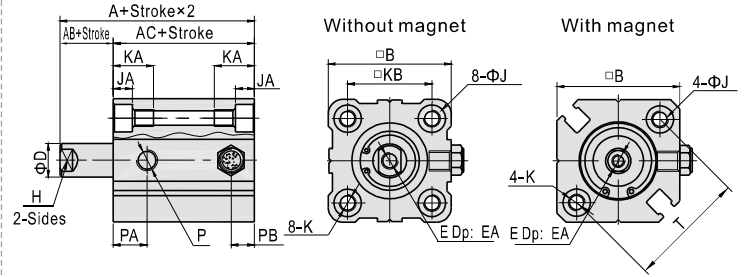

Φ20 Φ25

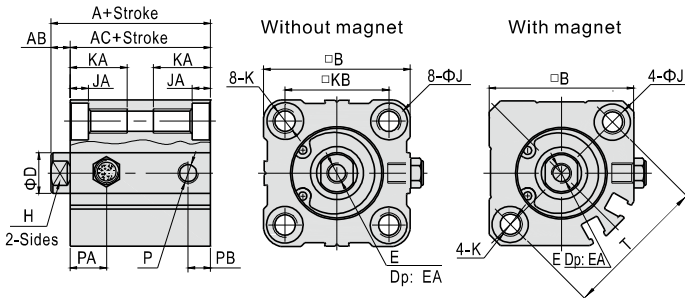

Φ20 Φ25

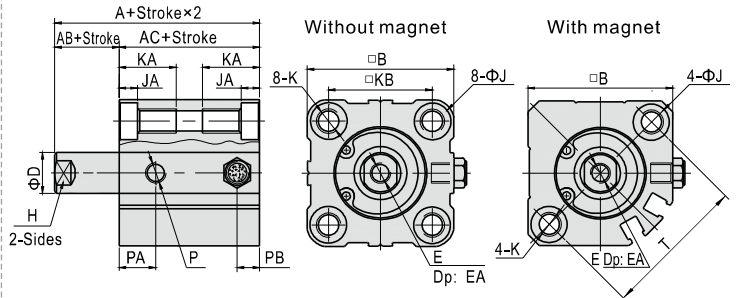

Φ32-Φ63

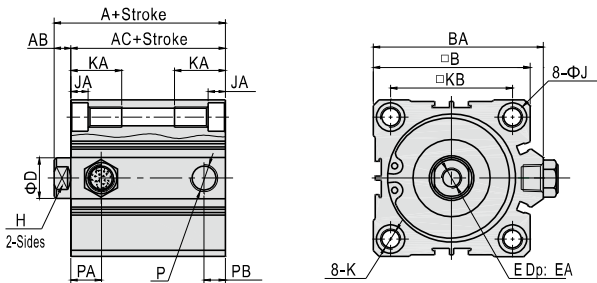

Φ32-Φ63

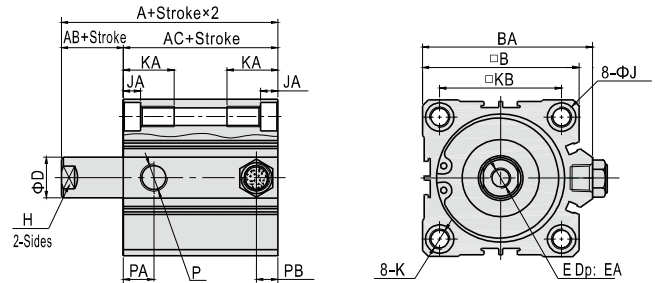

Bore size/Item Stroke	A(Without magnet)			A(With magnet)			AB	AC(Without magnet)			AC(With magnet)			B	BA	D	E	EA
	5/10	15/20	25/30	5/10	15/20	25/30		5/10	15/20	25/30	5/10	15/20	25/30					
12	25.5	30.5	-	36.5	41.5	-	3.5	22	27	-	33	38	-	25	-	6	M3×0.5	6
16	27	32	-	39	44	-	3.5	23.5	28.5	-	35.5	40.5	-	29	-	8	M4×0.7	8
20	29	34	39	41	46	51	4.5	24.5	29.5	34.5	36.5	41.5	46.5	36	-	10	M5×0.8	7
25	32.5	37.5	42.5	42.5	47.5	52.5	5	27.5	32.5	37.5	37.5	42.5	47.5	40	-	12	M6×1.0	12
32	35	40	45	45	50	55	7	28	33	38	38	43	48	45	49.5	16	M8×1.25	13
40	41.5	46.5	51.5	51.5	56.5	61.5	7	34.5	39.5	44.5	44.5	49.5	54.5	53	57	16	M8×1.25	13
50	48.5	53.5	58.5	58.5	63.5	68.5	8	40.5	45.5	50.5	50.5	55.5	60.5	64	71	20	M10×1.5	15
63	54	59	64	64	69	74	8	46	51	56	56	61	66	77	84	20	M10×1.5	15

Bore size/Item	H	J	JA	K		KA	KB	P	PA(Without magnet)	PA(With magnet)	PB(Without magnet)	PB(With magnet)	T
				Thru.hole	Φ								
12	5	6	3.5	M4×0.7	Φ3.4	11	15.5	M5×0.8	7.5	9	5	7	22
16	6	6	3.5	M4×0.7	Φ3.4	11	20	M5×0.8	8	9.5	5.5	5.5	28
20	8	9	5.5	M6×1.0	Φ5.2	17	25.5	M5×0.8	9	9.5	5.5	5.5	36
25	10	9	5.5	M6×1.0	Φ5.2	17	28	M5×0.8	11	11	5.5	5.5	40
32	14	9	5.5	M6×1.0	Thru.hole:Φ5.2	17	34	1/8"	10.5	10.5	7.5	7.5	-
40	14	9	5.5	M6×1.0	Thru.hole:Φ5.2	17	40	1/8"	11	11	8	8	-
50	17	10.5	6.5	M8×1.25	Thru.hole:Φ6.8	22	50	1/4"	10.5	10.5	10.5	10.5	-
63	17	14	9	M10×1.5	Thru.hole:Φ8.5	28.5	60	1/4"	15	15	10.5	10.5	-



# Compact cylinder

## ACQ Series

### ACQD

φ12, φ16

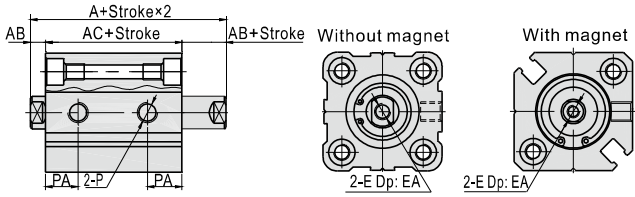

### ACQJ

φ12, φ16

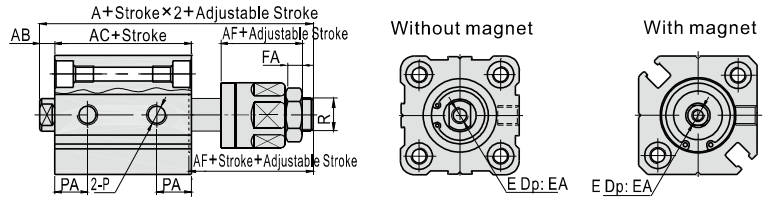

φ20 φ25

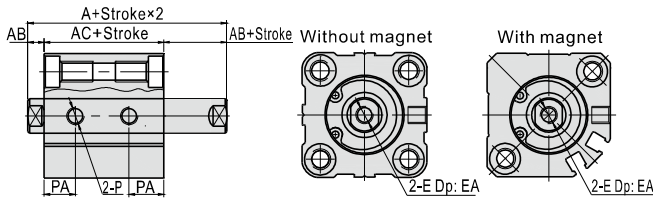

φ20 φ25

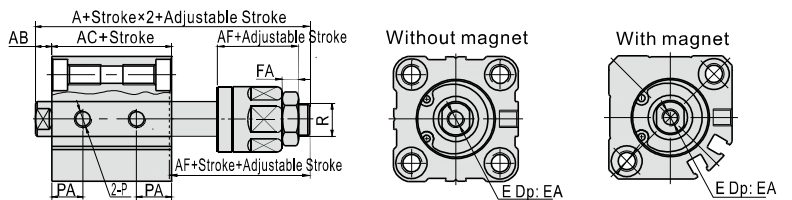

φ32~φ100

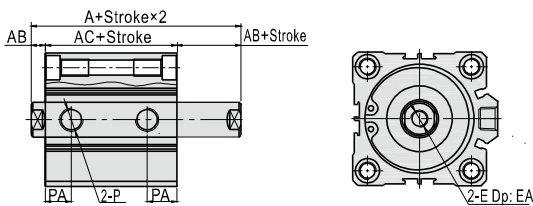

φ32~φ100

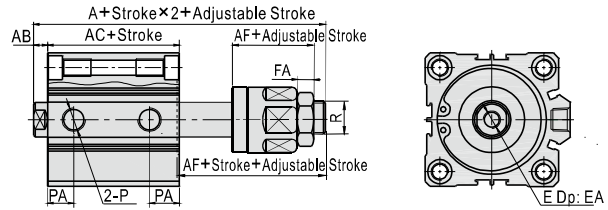

Item	A(ACQD)		A(ACQJ)		AC(ACQD)		AC(ACQJ)		AB	AF	E	EA	FA	PA	R
	Without magnet	With magnet	Without magnet	With magnet	Without magnet	With magnet	Without magnet	With magnet							
12	32.2	39.4	45.2	52.4	25.2	32.4	25.2	32.4	3.5	17	M3×0.5	6	4	9	M5×0.8
16	33	43	50	60	26	36	26	36	3.5	21	M4×0.7	8	5	9.5	M6×1.0
20	35	47	55	67	26	38	26	38	4.5	25	M5×0.8	7	6	9.5	M8×1.25
25	39	49	60.5	70.5	29	39	29	39	5	27	M6×1.0	9.5(St=5)/12(St>5)	6	11	M10×1.25
32	44.5	54.5	64.9	74.9	30.5	40.5	30.5	40.5	7	28	M8×1.25	9(St≤10)/13(St>10)	7	10	M12×1.25
40	54	64	74.5	84.5	40	50	40	50	7	28	M8×1.25	11(St≤10)/13(St>10)	7	13	M12×1.25
50	56.5	66.5	77	87	40.5	50.5	40.5	50.5	8	29	M10×1.5	12(St≤10)/15(St>10)	8	13.5	M16×1.5
63	58	68	78.4	88.4	42	52	42	52	8	29	M10×1.5	12(St≤10)/15(St>10)	8	14.5(St=5) 16(St>5)	M16×1.5
80	71	81	95.8	105.8	51	61	51	61	10	35.5	M16×2.0	14(St≤15)/20(St>15)	10	16	M20×1.5
100	84.5	94.5	114.3	124.3	60.5	70.5	60.5	70.5	12	42.5	M20×2.5	20(St≤25)/26(St>25)	13.5	21	M27×2.0

Remark) The unmarked dimension is the same as ACQ standard type. Please refer to this page for male thread dimensions.

### Male thread

(Bore size: φ12~φ100, Stroke≤100)

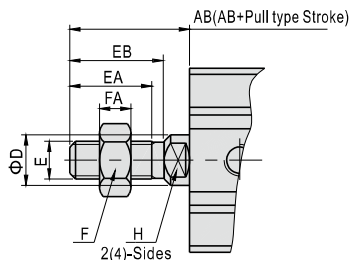

Bore size/Item	AB	D	E	EA	EB	F	FA	H
12	14	6	M5×0.8	9	10	8	4	5
16	15.5	8	M6×1.0	10	11.5	10	5	6
20	18.5	10	M8×1.25	12	13.5	12	6	8
25	22.5	12	M10×1.25	15	17	17	6	10
32	28.5	16	M14×1.5	20.5	23.5	19	8	14
40	28.5	16	M14×1.5	20.5	23.5	19	8	14
50	34	20	M18×1.5	25.5	27.5	27	11	17
63	33.5	20	M18×1.5	26	28	27	11	17
80	43.5	25	M22×1.5	32.5	35.5	32	13	22
100	43.5	32	M26×1.5	32.5	35.5	36	13	27

# Compact cylinder

## ACQ Series——Big bore size



### Symbol



### Product feature

1. JIS standard is implemented.
2. C clip is adopted to connect the cylinder body and back cover or front cover to make it compact and reliable.
3. The internal diameter of the body is treated with rolling followed by the treatment of hard anodizing, forming an excellent abrasion resistance and durability.
4. The seal of piston adopts heterogeneous two-way seal structure. It has compact dimension and the function of grease reservation.
5. Compact structure can effectively save installation space.
6. There are magnetic switch slots around the cylinder body, which is convenient to install inducting switch.

### Specification

Bore size(mm)	125	140	160
Acting type	Double acting		
Fluid	Air(to be filtered by 40μm filter element)		
Operating pressure	0.15~1.0MPa(22~145psi)		
Proof pressure	1,5MPa(215psi)		
Temperature °C	-20~70		
Speed range mm/s	30~500		
Stroke tolerance	Stroke≤100 $+1.0_0$ Stroke>100 $+1.5_0$		
Cushion type	Bumper		
Port size [Note1]	3/8"		

[Note1] PT thread, G thread and NPT thread are available.  
Add) Refer to P362 for detail of sensor switch.

### Stroke

Bore size (mm)	Standard stroke (mm)	Max.std stroke
125	10 20 30 40 50 75 100 125 150 175 200 250 300	300
140		
160		

Note) Please contact the company for other special strokes.

### Ordering code

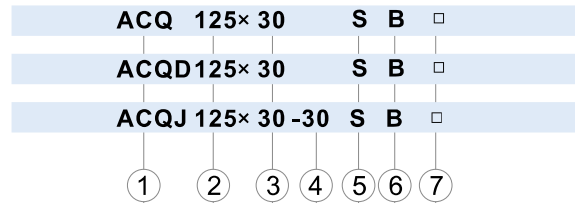

① Model	② Bore size	③ Stroke	④ Adjustable Stroke	⑤ Magnet	⑥ Rod type	⑦ Thread type
ACQ: Compact cylinder (Double acting)	125 140 160	Refer to stroke table for details	No this code	S: With magnet	Blank: Female thread B: Male thread	Blank: PT G: G T : NPT
ACQD: Compact cylinder (Double rod)						
ACQJ: Compact cylinder (Adjustable stroke)			10 20 30 40 50 75 100			

### Inner structure and material of major parts

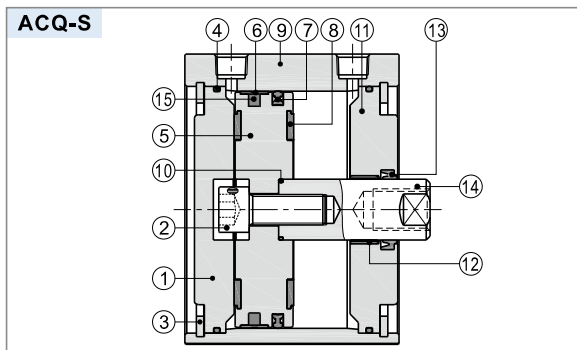

NO.	Item	Material	NO.	Item	Material
1	Back cover	Aluminum alloy	9	Body	Aluminum alloy
2	Screw	Carbon steel	10	O-ring	NBR
3	C clip	Spring steel	11	Front cover	Aluminum alloy
4	O-ring	NBR	12	Bushing	Wear resistant material
5	Piston	Aluminum alloy	13	Front cover packing	NBR
6	Wear ring	Wear resistant material	14	Piston rod	Carbon steel with 20μm chrome plated
7	Piston seal	NBR			
8	Bumper	NBR	15	Magnet	Rubber

# Compact cylinder

## ACQ Series—Big bore size

### Dimensions

#### ACQ

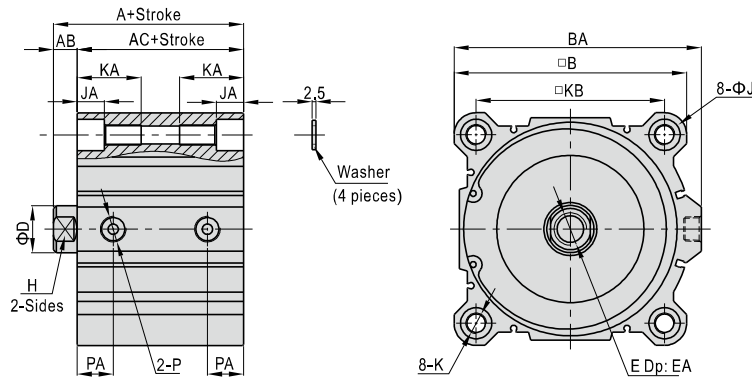

Bore size/Item	A	AB	AC	B	BA	D	E	EA(St≤10)	EA(St>10)	H	J	JA	K	KA	KB	P	PA
125	99	16	83	142	153	32	M22×2.5	22.5	30	27	21.2	18.4	M14×2.0 Thru.hole:Φ12.4	43.5	114	3/8"	24.5
140	99	16	83	158	168	32	M22×2.5	22.5	30	27	21.2	18.4	M14×2.0 Thru.hole:Φ12.4	43.5	128	3/8"	24.5
160	108	17	91	178	188	40	M24×3.0	26.5	33	36	24.2	21.2	M16×2.0 Thru.hole:Φ14.4	49	144	3/8"	27.5

Remark) Washer must be used when the cylinder be mounted by through hole. Please refer to this page for male thread dimensions.

#### ACQD

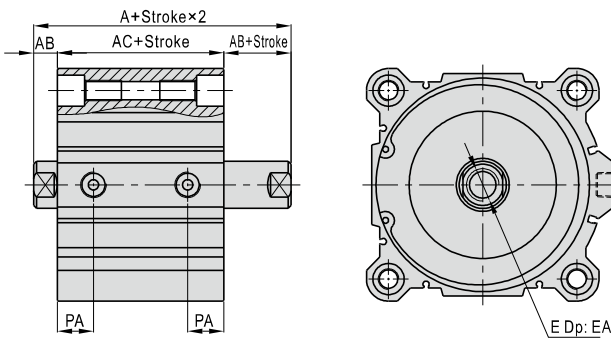

Bore size/Item	A	AB	AC	E	EA		PA
					St≤10	St>10	
125	115	16	83	M22×2.5	22.5	30	24.5
140	115	16	83	M22×2.5	22.5	30	24.5
160	125	17	91	M24×3.0	26.5	33	27.5

Remark) The unmarked dimension is the same as ACQ standard type. Please refer to this page for male thread dimensions.

#### ACQJ

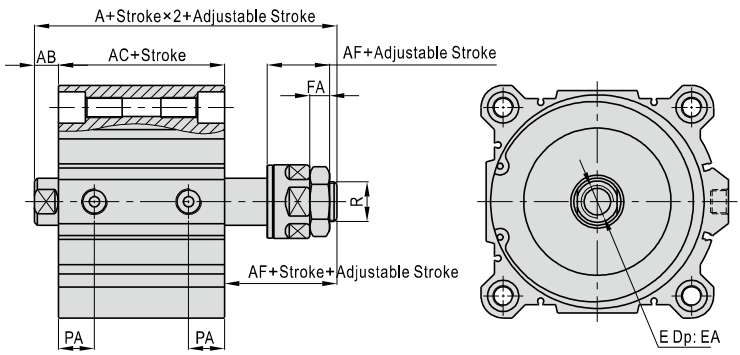

Bore size/Item	A	AB	AC	AF	E	EA		FA	PA	R
						St≤10	St>10			
125	140.8	16	83	42.5	M22×2.5	22.5	30	13.5	24.5	M27×2.0
140	140.8	16	83	42.5	M22×2.5	22.5	30	13.5	24.5	M27×2.0
160	175.3	17	91	68	M24×3.0	26.5	33	18	27.5	M36×2.0

Remark) The unmarked dimension is the same as ACQ standard type. Please refer to this page for male thread dimensions.

#### Male thread

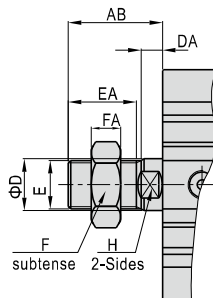

Bore size/Item	AB	D	E	EA	EB	F	FA	H
125	58	32	M30×1.5	42	45	46	18	27
140	58	32	M30×1.5	42	45	46	18	27
160	64	40	M36×1.5	47	50	55	21	36

# Compact cylinder

## ACQ Series—Longer stroke



### Symbol

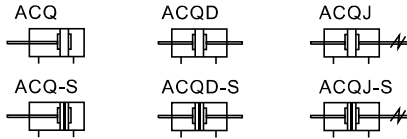

### Product feature

1. JIS standard is implemented.
2. C clip is adopted to connect the cylinder body and back cover or front cover, and riveted structure is adopted to connect piston and piston rod to make it compact and reliable.
3. The internal diameter of the body is treated with rolling followed by the treatment of hard anodizing, forming an excellent abrasion resistance and durability.
4. The seal of piston adopts heterogeneous two-way seal structure. It has compact dimension and the function of greasel reservation.
5. Compact structure can effectively save installation space.
6. There are magnetic switch slots around the cylinder body, which is convenient to install inducting switch.
7. Installing accessories with various specifications are optional.

### Specification

Bore size(mm)	32	40	50	63	80	100
Acting type	Double acting					
Fluid	Air(to be filtered by 40µm filter element)					
Operating pressure	0.15~1.0MPa(22~145psi)					
Proof pressure	1.5MPa(215psi)					
Temperature °C	-20~70					
Speed range mm/s	30~500					
Stroke tolerance	+1.5 0					
Cushion type	Bumper					
Port size [Note1]	1/8"		1/4"		3/8"	

[Note1] PT thread, G thread thread and NPT thread are available.  
Add) Refer to P362 for detail of sensor switch.

### Stroke

Bore size(mm)	Standard stroke (mm)						Max.std stroke
32 40 50 63 80 100	125	150	175	200	250	300	300

Note) Within allowable stroke scope, when the stroke is larger than the maximum value, it shall be treated as non-standard one. Please contact the company for other special strokes.

### Ordering code

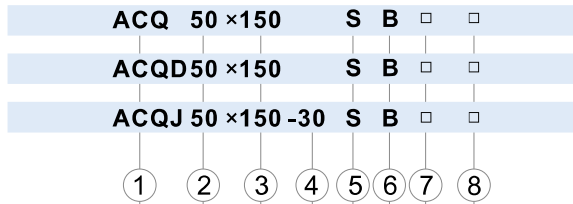

① Model	② Bore size	③ Stroke	④ Adjustable Stroke	⑤ Magnet	⑥ Rod type	⑦ Mounting type [Note1]	⑧ Thread type
ACQ: Compact cylinder (Double acting)	32 40 50 63 80 100	Refer to stroke table for details	No this code	Blank: Without magnet S: With magnet	Blank: Female thread B: Male thread	Blank: No accessories FA: FA type FB: FB type CB: CB type LB: LB type	Blank: PT G: G T: NPT
ACQD: Compact cylinder (Double rod)						Blank: No accessories FA: FA type FB: FB type LB: LB type	
ACQJ: Compact cylinder (Adjustable stroke)			10 20 30 40 50 75 100				

[Note1] Please refer to page 120~121 for accessory parts.

### Inner structure and material of major parts

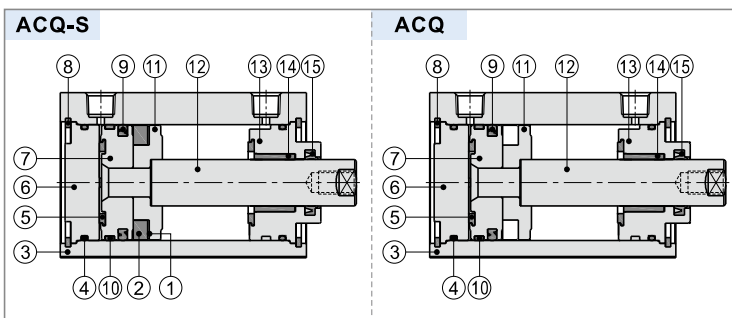

NO.	Item	Material	NO.	Item	Material
1	Magnet washer	NBR	10	Wear ring	No(Φ32)\Wear resistant material(Others)
2	Magnet	Plastic	11	Magnet holder	Aluminum alloy
3	Body	Aluminum alloy	12	Piston rod	Carbon steel with 20µm chrome plated
4	O-ring	NBR	13	Front cover	Aluminum alloy
5	Bumper	NBR	14	Bushing	No(Φ32)\Wear resistant material(Others)
6	Back cover	Aluminum alloy	15	Front cover packing	NBR
7	Piston	Aluminum alloy			
8	C clip	Spring steel			
9	Piston seal	NBR			



# Compact cylinder

## ACQ Series—Longer stroke

### Dimensions

#### ACQ

φ32-φ100(Stroke > 100)

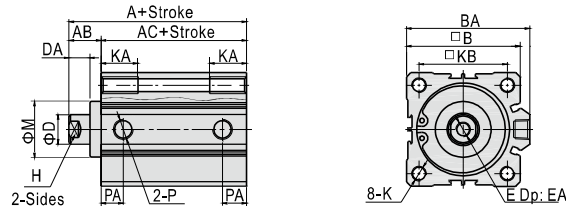

Bore size/Item	A	AB	AC	B	BA	D	DA	E	EA	H	K	KA	KB	M	P	PA
32	62.5	17	45.5	45	49.5	16	12	M8×1.25	13	14	M6×1.0 Thru.hole:Φ5.2	17	34	22	1/8"	12.5
40	72	17	55	53	57	16	12	M8×1.25	13	14	M6×1.0 Thru.hole:Φ5.2	17	40	28	1/8"	14
50	73.5	18	55.5	64	71	20	13	M10×1.5	15	17	M8×1.25 Thru.hole:Φ6.7	22	50	35	1/4"	14
63	75	18	57	77	84	20	13	M10×1.5	15	17	M10×1.5 Thru.hole:Φ8.5	27	60	35	1/4"	16.5
80	86	20	66	98	104	25	15	M16×2.0	21	22	M12×1.75 Thru.hole:Φ10.4	32	77	43	3/8"	19
100	97.5	22	75.5	117	123.5	32	17	M20×2.5	27	27	M12×1.75 Thru.hole:Φ10.4	33	94	59	3/8"	23

#### ACQD

φ32-φ100(Stroke > 100)

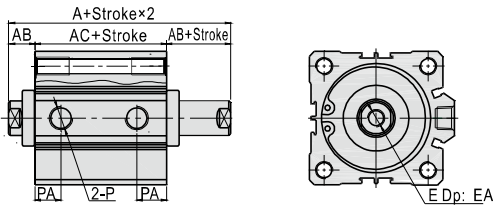

#### ACQJ

φ32-φ100(Stroke > 100)

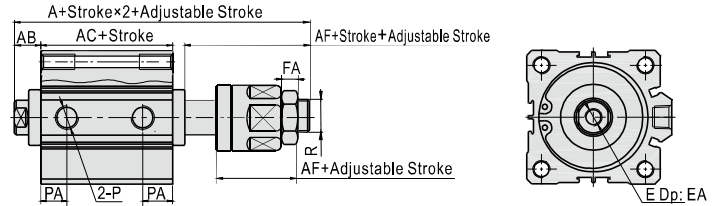

Bore size/Item	A(ACQD)		A(ACQJ)		AB	AC		AF	EA	FA	PA	R
	Without magnet	With magnet	Without magnet	With magnet		Without magnet	With magnet					
32	79.5	89.5	95.5	105.5	17	45.5	55.5	28	13	7	12.5	M12×1.25
40	89	99	105	115	17	55	65	28	13	7	14	M12×1.25
50	91.5	101.5	107.5	117.5	18	55.5	65.5	29	15	8	14	M16×1.5
63	93	103	109	119	18	57	67	29	15	8	16.5	M16×1.5
80	106	116	126.5	136.5	20	66	76	35.5	21	10	19	M20×1.5
100	119.5	129.5	145	155	22	75.5	85.5	42.5	27	13.5	23	M27×2.0

Remark) The unmarked dimension is the same as ACQ standard type.

#### Male thread (Bore size: φ32-φ100 Stroke>100 Longer type)

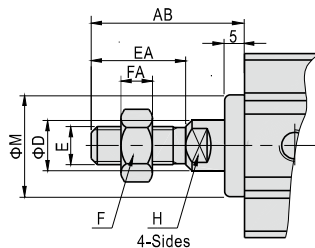

Bore size/Item	AB	D	E	EA	FA	F	H	M
32	38.5	16	M14×1.5	23	8	19	14	22
40	38.5	16	M14×1.5	23	8	19	14	28
50	43.5	20	M18×1.5	28	11	27	17	35
63	43.5	20	M18×1.5	28	11	27	17	35
80	53.5	25	M22×1.5	35	13	32	22	43
100	53.5	32	M26×1.5	35	13	36	27	59

# Compact cylinder

ACQ Series—With guider type



## Specification

Bore size(mm)	12	16	20	25	32	40	50	63	80	100
Acting type	Double acting									
Fluid	Air(to be filtered by 40μm filter element)									
Operating pressure	0.15~1.0MPa(22~145psi)									
Proof pressure	1.5MPa(215psi)									
Temperature °C	-20~70									
Speed range mm/s	30~500									
Stroke tolerance	+1.0 0									
Cushion type	Bumper									
Port size [Note1]	M5×0.8					1/8"		1/4"		3/8"
Non-rotating tolerance [Note2]	±0.2°					±0.15°				

[Note1] PT thread, G thread and NPT thread are available.

[Note2] Retract position.

Add) Refer to P362 for detail of sensor switch.

## Symbol

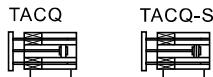

## Product feature

1. JIS standard is implemented and with guider.
2. C clip is adopted to connect the cylinder body and back cover or front cover to make it compact and reliable.
3. The internal diameter of the body is treated with rolling followed by the treatment of hard anodizing, forming an excellent abrasion resistance and durability.
4. The seal of piston adopts heterogeneous two-way seal structure. It has compact dimension and the function of greasel reservation.
5. Compact structure can effectively save installation space.
6. There are magnetic switch slots around the cylinder body, which is convenient to install inducting switch.
7. Double rod non-rotating structure enables to bear large working load and lateral load.

## Stroke

Bore size(mm)	Standard stroke (mm)											Max.std stroke (mm)	Middle stroke range(mm)	
	5	10	15	20	25	30	35	40	45	50	75			100
12 16	●	●	●	●	●	●	●	x	x	x	x	x	30	1~29
20 25	●	●	●	●	●	●	●	●	●	●	x	x	50	1~49
32 40	●	●	●	●	●	●	●	●	●	●	●	●	100	1~99
50 63 80 100	x	●	●	●	●	●	●	●	●	●	●	●	100	5~99

[Note] The dimensions of non-std stroke cylinder has the same dimensions as the next longer stroke std. stroke cylinder. e.g. 23mm stroke cylinder has the same dimensions of 25 std. stroke cylinder.

Please contact the company for other special strokes.

## Ordering code

TACQ 50 × 100 S □

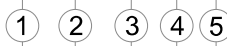

① Model	② Bore size	③ Stroke	④ Magnet	⑤ Thread type
TACQ: Compact cylinder (Double acting with guider)	12 16 20 25 32 40 50 63 80 100	Refer to stroke table for details	Blank: Without magnet S: With magnet	Blank: PT G: G T: NPT

## Inner structure and material of major parts

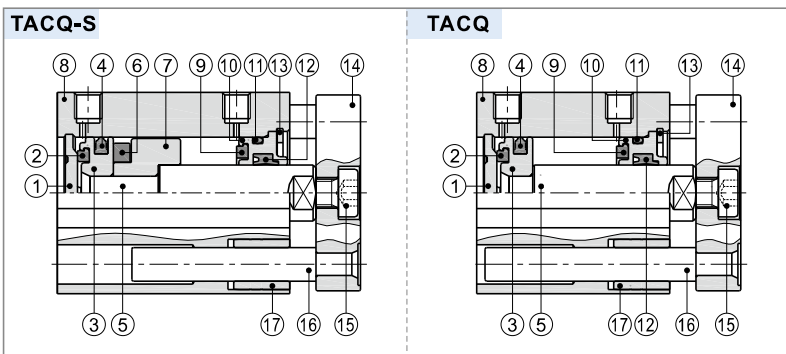

NO.	Item	Material	NO.	Item	Material
1	Back cover	Aluminum alloy	10	Front cover	Aluminum alloy
2	Bumper	NBR	11	O-ring	NBR
3	Piston	Aluminum alloy	12	Front cover packing	NBR
4	Piston seal	NBR	13	C clip	Spring steel
5	Piston rod	Carbon steel with 20μm chrome plated	14	Fixing plate	Aluminum alloy
6	Magnet	Sintered metal (Neodymium-iron-boron)	15	Screw	Carbon steel
7	Magnet holder	Aluminum alloy	16	Leader	Stainless steel(φ12-φ40)
8	Body	Aluminum alloy			Carbon steel with 20μm chrome plated (φ50-φ100)
9	Wear ring	NBR	17	Bushing	Brass

# Compact cylinder

## ACQ Series—With guider type

### Installation and application

1. TACQ series cylinder is designed with double guide rod which is non-rotating. Make sure the non-rotating accuracy of the fixing plate is in the allowable range.

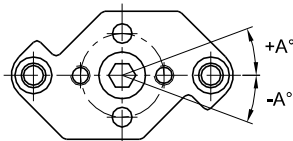

Bore size	12,16	20,25,32,40,50,63,80,100
Non-rotating tolerance	±0.2°	±0.15°

2. Do not apply reverse torque to the piston rods. The torque beyond the limits may cause malfunction or reduction of the service life.

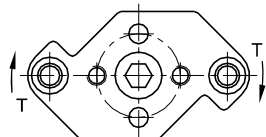

Unit : N·m

Bore size\Stroke	5	10	15	20	25	30	35	40	45	50	75	100
12	0.11	0.10	0.08	0.07	0.07	0.06	-	-	-	-	-	-
16	0.15	0.12	0.11	0.10	0.09	0.08	-	-	-	-	-	-
20	0.37	0.32	0.28	0.25	0.23	0.21	0.19	0.18	0.17	0.16	-	-
25	0.40	0.35	0.31	0.28	0.25	0.23	0.21	0.20	0.18	0.17	-	-
32	0.66	0.59	0.53	0.49	0.45	0.42	0.39	0.36	0.34	0.32	0.25	0.20
40	1.06	0.96	0.88	0.81	0.75	0.70	0.65	0.61	0.58	0.55	0.43	0.36
50	-	1.70	1.56	1.45	1.35	1.26	1.19	1.12	1.06	1.01	0.80	0.67
63	-	3.90	3.62	3.37	3.15	2.96	2.80	2.65	2.51	2.39	1.92	1.61
80	-	7.44	6.98	6.56	6.20	5.87	5.57	5.31	5.07	4.84	3.98	3.37
100	-	11.85	11.19	10.61	10.08	9.60	9.17	8.77	8.41	8.07	6.73	5.77

3. Make sure the lateral load on the mounting bracket is within the limits. Any exceeding may cause malfunction or reduction of the service life.

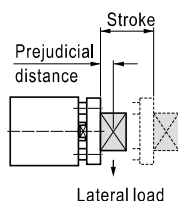
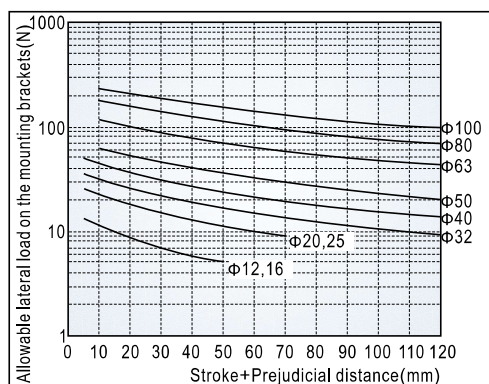

4. Make sure the load quality and the maximum speed are within the limits. Any exceeding may cause malfunction or reduction of the service life.

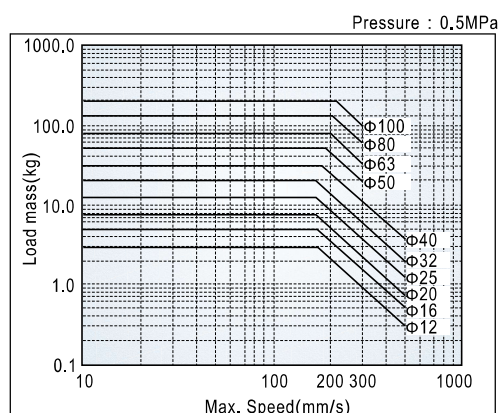

5. Caution before mounting:

- 5.1) Do not put hands between the mounting bracket and cylinder, which may cause damage to a human body when the piston rod retracts.

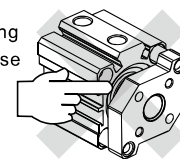

- 5.2) Make sure the external force against the mounting bracket is concentric with the piston rod. Any extra torque may cause damage to the cylinder.

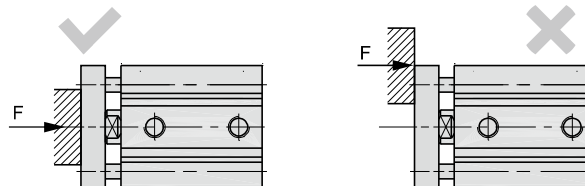

- 5.3) Install the fixture onto the mounting bracket only when the piston rod is in the retraction state. Do not apply the installation torque on the guide rod.
- 5.4) Avoid any damage on piston rod and guide rod, which may cause damage on seals and air leakage or malfunction.

# Compact cylinder



## ACQ Series—With guider type

### Dimensions

**Φ12/Φ16**

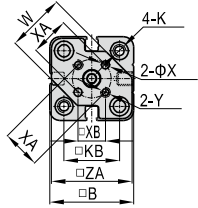
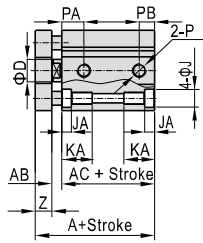

**Φ20/Φ25**

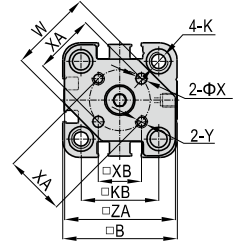
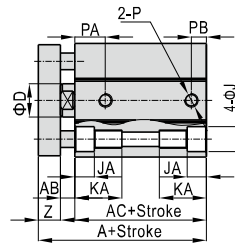

Bore size\Item	A		AC		AB	B	D	J	JA	K
	Without magnet	With magnet	Without magnet	With magnet						
12	26.5	37.5	17.3	28.3	3	26	6	6	3.5	M4×0.7 Thru.hole:Φ3.4
16	28	40	19	31	3	30	8	6	3.5	M4×0.7 Thru.hole:Φ3.4
20	32	44	20.5	32.5	3.5	36	10	9	5.5	M6×1.0 Thru.hole:Φ5.2
25	35.5	45.5	23	33	4.5	41	12	9	5.5	M6×1.0 Thru.hole:Φ5.2

Bore size\Item	KA	KB	P	PA		PB		W	X	XA	XB	Y	Z	ZA
				Without magnet	With magnet	Without magnet	With magnet							
12	11.5	15.5	M5×0.8	7.5	9	5	7	15	3	10	7.1	M3×0.5	6	25
16	11.5	20	M5×0.8	8.5	10	5.5	5.5	21	3	14	9.9	M3×0.5	6	29
20	18	25.5	M5×0.8	10	10.5	5.5	5.5	26	4	17	12	M4×0.7	8	35
25	17.5	28	M5×0.8	11.5	11.5	5.5	5.5	30	5	22	15.6	M5×0.8	8	40

**Φ32~Φ100**

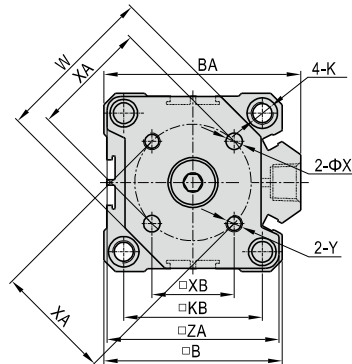
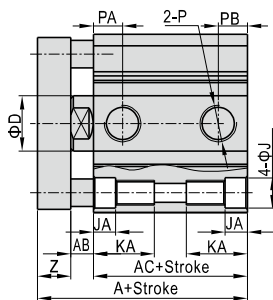

Bore size\Item	A(Without magnet)		A (With magnet)	AB	AC(Without magnet)		AC (With magnet)	B	BA	D	J	JA	K
	St≤50	St≥75			St≤50	St≥75							
32	40	50	50	6.5	23.5	33.5	33.5	45	49.5	16	9	5.5	M6×1.0 Thru.hole:Φ5.2
40	46.5	56.5	56.5	6.6	30	40	40	53	57	16	9	5.5	M6×1.0 Thru.hole:Φ5.2
50	50.5	60.5	60.5	7.5	31	41	41	64	71	20	10.5	6.5	M8×1.25 Thru.hole:Φ6.7
63	56	66	66	8	36	46	46	77	84	20	14	9	M10×1.5 Thru.hole:Φ8.5
80	67.5	77.5	77.5	10	43.5	53.5	53.5	98	104	25	17	11	M12×1.75 Thru.hole:Φ10.4
100	81	91	91	12	53	63	63	117	123.5	32	17	11	M12×1.75 Thru.hole:Φ10.4

Bore size\Item	KA	KB	P	PA		PB		W	X	XA	XB	Y	Z	ZA
				(Without magnet)	(With magnet)	(Without magnet)	(With magnet)							
32	17.5	34	1/8"	8	10.5	6.5	7.5	37	5	28	19.8	M5×0.8	10	43
				11		7.5								
40	17.5	40	1/8"	11	11	8	8	46	5	33	23.3	M5×0.8	10	51
50	22.5	50	1/4"	10.5	10.5	11	11	58	6	42	29.7	M6×1.0	12	62
63	28.5	60	1/4"	15	15	10.5	10.5	69	6	50	35.4	M6×1.0	12	75
80	35.5	77	3/8"	16	16	14	14	90	8	65	46	M8×1.25	14	95
100	35.5	94	3/8"	20	20	17.5	17.5	113.5	10	80	56.6	M10×1.5	16	114.5



# Compact cylinder

## ACQ Series—Accessories

### List for ordering code of accessories

Accessories Bore size	Mounting accessories			Knuckle				Sensor switch
	LB	FA/FB	CB	I	Y	F	U	
12	F-ACQ12LB	F-ACQ12FA	F-ACQ12CB	F-ACQ12I	F-ACQ12Y	-	F-M5X080U	CMSG DMSG EMSG
16	F-ACQ16LB	F-ACQ16FA	F-ACQ16CB	F-ACQ16I	F-ACQ16Y	-	F-M6X100U	
20	F-ACQ20LB	F-ACQ20FA	F-ACQ20CB	F-ACQ20I	F-ACQ20Y	F-M8X125F	F-M8X125U	
25	F-ACQ25LB	F-ACQ25FA	F-ACQ25CB	F-ACQ25I	F-ACQ25Y	F-M10X125F	F-M10X125U	CMSJ DMSJ CMSG DMSG EMSG
32	F-ACQ32LB	F-ACQ32FA	F-ACQ32CB	F-ACQ32I	F-ACQ32Y	F-M14X150F	F-M14X150U	
40	F-ACQ40LB	F-ACQ40FA	F-ACQ40CB					
50	F-ACQ50LB	F-ACQ50FA	F-ACQ50CB	F-ACQ50I	F-ACQ50Y	F-M18X150F	F-M18X150U	
63	F-ACQ63LB	F-ACQ63FA	F-ACQ63CB					
80	F-ACQ80LB	F-ACQ80FA	F-ACQ80CB					F-ACQ80I
100	F-ACQ100LB	F-ACQ100FA	F-ACQ100CB	F-ACQ100I	F-ACQ100Y	-	F-M26X150U	CMSH/DMSH EMSH CMSG/DMSG EMSG
125	-	-	-					
140	-	-	-					
160	-	-	-					

### Accessory selection

Cylinder model	Accessories	Mounting accessories				Knuckle[Note2]				Sensor switch[Note3]		
		LB	FA	FB	CB [1]	I	Y	U	F	CMSJ DMSJ	CMSG/DMSG EMSG	CMSH/DMSH EMSH
ACQ	Female thread	Without magnet				x	x	x	x	x	x	x
		With magnet	•	•	•	•	•	•	•	•	•	•
	Male thread	Without magnet				•	•	•	•	x	x	x
		With magnet	•	•	•	•	•	•	•	•	•	•
ASQ ATQ	Female thread	Without magnet				x	x	x	x	x	x	x
		With magnet	•	•	•	•	•	•	•	•	•	•
	Male thread	Without magnet				•	•	•	•	x	x	x
		With magnet	•	•	•	•	•	•	•	•	•	•
ACQD ACQJ	Female thread	Without magnet				x	x	x	x	x	x	x
		With magnet	•	•	x	•	•	•	•	•	•	•
	Male thread	Without magnet			x	•	•	•	•	x	x	x
		With magnet	•	•	•	•	•	•	•	•	•	•

### Material of accessories

Accessories Bore size	Mounting accessories				Knuckle			
	LB	FA	FB	CB	I	Y	F	U
12, 15	△	●	●	●	▲	▲	▲	▲
20, 25	△	●	●	●	▲	▲	▲	▲
32~100	△	●	●	■	▲	■	▲	▲

●—Aluminum alloy ; ■—Cast Steel  
▲—S45C ; △—SPCC

[Note1] CB is attached with relevant PIN.  
Mounting accessories and Knuckle unavailable for bore size 125, 140, 160 cylinder.

[Note2] Please refer to P358~361 for knuckle detail.

[Note3] CMSH/DMSH sensor switch only available for bore size 125, 140, 160 cylinder.

### Dimensions

#### FA/FB

φ12~φ25

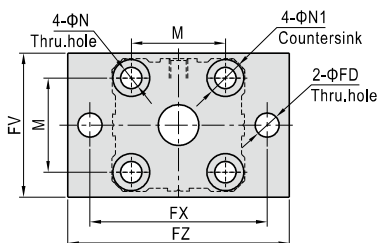

φ32~φ100

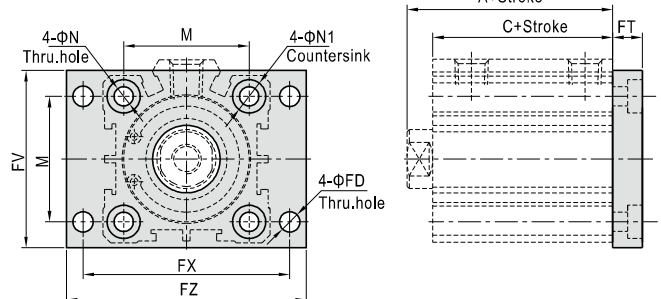

Bore size/Item	A [Note1]				C				M	N	N1	FD	FT	FV	FX	FZ
	Without magnet	55	≥60	With magnet	Without magnet	55	≥60	With magnet								
Stroke	≤50	55	≥60	With magnet	≤50	55	≥60	With magnet								
12	20.5	-	-	31.5	17	-	-	28	15.5	4.5	7.5	4.5	5.5	25	45	55
16	22	22	-	34	18.5	18.5	-	30.5	20	4.5	7.5	4.5	5.5	30	45	55
20	24	-	34	36	19.5	-	29.5	31.5	25.5	6.5	10.5	6.5	8	39.5	48	60
25	27.5	-	37.5	37.5	22.5	-	32.5	32.5	28	6.5	10.5	6.5	8	42	52	64
32	30	-	40	40	23	-	33	33	34	6.5	10.5	5.5	8	48	56	65
40	36.5	-	46.5	46.5	29.5	-	39.5	39.5	40	6.5	10.5	5.5	8	54	62	72
50	38.5	-	48.5	48.5	30.5	-	40.5	40.5	50	8.5	13.5	6.5	9	67	76	89
63	44	-	54	54	36	-	46	46	60	10.5	16.5	9	10	80	92	108
80	53.5	-	63.5	63.5	43.5	-	53.5	53.5	77	12.5	18.5	11	12	99	116	134
100	65	-	75	75	53	-	63	63	94	12.5	18.5	11	12	117	136	154

[Note] Value A and C in the above table are only for ACQ series.

Please refer to relevant content for value A and C of other series.



# Compact cylinder

## ACQ Series—Accessories

### LB

φ12-φ25

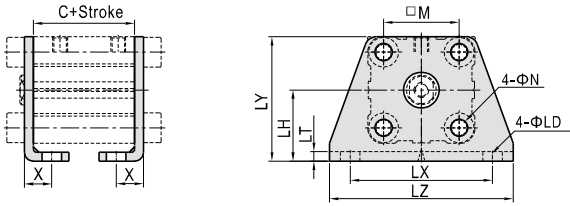

φ32-φ100

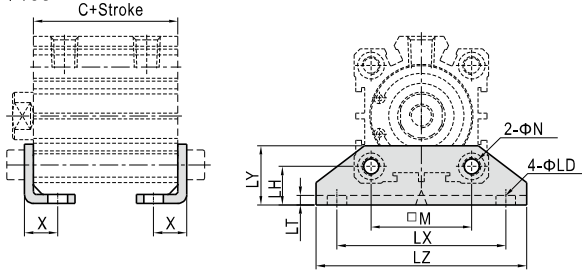

### CB

φ12-φ25

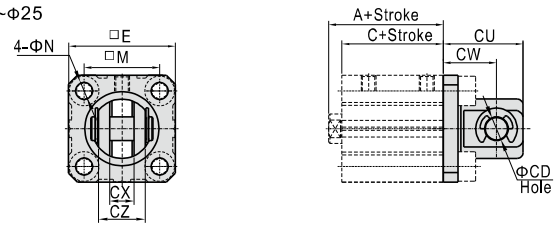

φ32-φ100

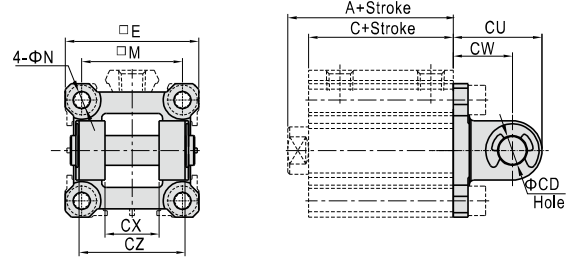

Bore size/Item	C [Note]			M	N	X	LD	LH	LT	LX	LY	LZ	
	Without magnet												With magnet
Stroke	≤50	55	≥60										
12	17	-	-	28	15.5	4.5	8	4.5	17	2	34	29.5	44
16	18.5	18.5	-	30.5	20	4.5	8	4.5	19	2	38	33.5	48
20	19.5	-	29.5	31.5	25.5	6.5	9.2	6.5	24	3	48	42	62
25	22.5	-	32.5	32.5	28	6.5	10.7	6.5	26	3	52	46	66
32	23	-	33	33	34	6.5	11.2	6.5	13	3	57	20	71
40	29.5	-	39.5	39.5	40	6.5	11.2	6.5	13	3	64	20	78
50	30.5	-	40.5	40.5	50	8.5	12.2	8.5	14	3	79	22	95
63	36	-	46	46	60	10.5	13.7	10.5	16	3	95	26	113
80	43.5	-	53.5	53.5	77	13	16.5	13	20.5	4.5	118	32	140
100	53	-	63	63	94	13	23	13	24	6	137	36	162

[Note] Value C in the above table is only for ACQ series.  
Please refer to relevant content for value C of other series.

Item	A [Note]			C			E	M	N	C	D	C	U	C	W	C	X	Z
	Without magnet			With magnet														
Stroke	≤50	55	≥60	Without magnet	With magnet	Without magnet	With magnet											
12	20.5	-	-	31.5	17	-	-	28	25	15.5	4.5	5	20	14	5.3	9.8		
16	22	22	-	34	18.5	18.5	-	30.5	29	20	4.5	5	21	15	6.8	11.8		
20	24	-	34	36	19.5	-	29.5	31.5	36	25.5	6.5	8	27	18	8.3	15.8		
25	27.5	-	37.5	37.5	22.5	-	32.5	32.5	40	28	6.5	10	30	20	10.3	19.8		
32	30	-	40	40	23	-	33	33	45.5	34	6.5	10	30	20	18.3	35.8		
40	36.5	-	46.5	46.5	29.5	-	39.5	39.5	53.5	40	6.5	10	32	22	18.3	35.8		
50	38.5	-	48.5	48.5	30.5	-	40.5	40.5	64.5	50	8.5	14	42	28	22.3	43.8		
63	44	-	54	54	36	-	46	46	77.5	60	10.5	14	44	30	22.3	43.8		
80	53.5	-	63.5	63.5	43.5	-	53.5	53.5	98.5	77	12.5	18	56	38	28.3	55.8		
100	65	-	75	75	53	-	63	63	117.5	94	12.5	22	67	45	32.3	63.8		

[Note] Value A and C in the above table are only for ACQ series.  
Please refer to relevant content for value A and C of other series.

### Y Knuckle

F-ACQ12Y  
F-ACQ16Y  
F-ACQ20Y  
F-ACQ25Y

F-ACQ32Y  
F-ACQ50Y  
F-ACQ80Y  
F-ACQ100Y

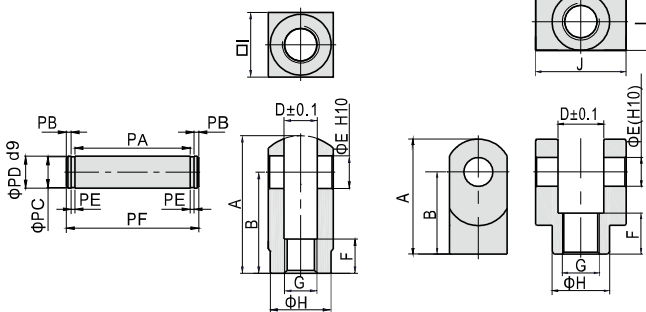

Type/Item	A	B	D	E	F	G	H	I	J	PA	PB	PC	PD	PE	PF
F-ACQ12Y	22	16	5.3	5	6	M5×0.8	9	10	-	10.2	1.5	4	5	0.7	14.6
F-ACQ16Y	28	21	6.6	5	11	M6×1.0	11	12	-	12.4	1.5	4	5	0.7	16.8
F-ACQ20Y	34	25	8.3	8	8.5	M8×1.25	15	16	-	16.2	1.5	7	8	0.9	21
F-ACQ25Y	41	30	10.3	10	10.5	M10×1.25	19	20	-	20.2	2	8	10	1.1	26.4
F-ACQ32Y	42	30	18.4	10	16	M14×1.5	22	22	36	36.2	2	8	10	1.1	42.4
F-ACQ50Y	56	40	22.4	14	20	M18×1.5	28	28	44	44.2	2	12	14	1.1	50.4
F-ACQ80Y	71	50	28.4	18	23	M22×1.5	38	38	56	56.2	2	15	18	1.7	63.6
F-ACQ100Y	79	55	32.4	22	24	M26×1.5	44	44	64	64.2	2.5	19	22	1.7	72.6

### I Knuckle

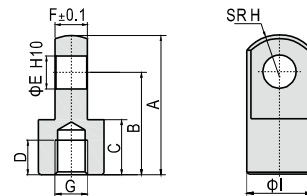

Type/Item	A	B	C	D	E	F	G	H	I
F-ACQ12I	21.5	16	9	6	5	4.7	M5×0.8	6.3	10
F-ACQ16I	32	25	11	8	5	6.2	M6×1.0	8.1	12
F-ACQ20I	34	25	13.5	8.5	8	7.7	M8×1.25	10.3	16
F-ACQ25I	41	30	16	11	10	9.7	M10×1.25	12.8	20
F-ACQ32I	42	30	16	14	10	17.6	M14×1.5	12	22
F-ACQ50I	56	40	20	18	14	21.6	M18×1.5	16	28
F-ACQ80I	71	50	23	21	18	27.6	M22×1.5	21	38
F-ACQ100I	79	55	24	22	22	31.6	M26×1.5	24	44